



2 DE DICIEMBRE DE 2024



LISTA DE PRECIOS

Perfilería de aluminio / Correderas y laterales de cajón / Bisagras
Manijas / Accesorios / Frente de placard
Puertas de aluminio / Tornillos / Filos



 **Clic aquí**



 **Clic aquí**

discontinuos!



**hasta agotar
stock**

 **Clic aquí**

 11-6124-9420 / 11-5471-2005

  arraialherrajes

 www.arraialherrajes.com.ar

 info@arraialherrajes.com.ar

 Av. Pte Perón 3121. Haedo, Buenos Aires.

01

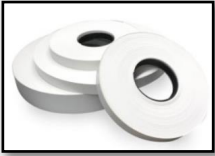

Tapacantos de PVC y preencolados. Pág.04



02

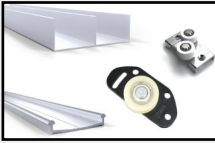

Frentes de placard y sist. corredizos. Pág.08



03



Iluminación LED para muebles. Pág.18



04



Puertas de aluminio y vidrio. Pág.22



05



Estanterías modulares. Pág.26



06



Tornillos, puntas y tarugos. Pág.27



07

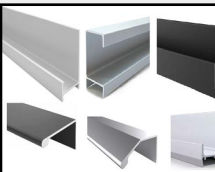

Perfiles y tapacantos de aluminio. Pág.32



08



Accesorios de armado. Pág.35



09



Patas y ruedas para muebles. Pág.44



10



Accesorios de cocina. Pág.46



11



Accesorios de placard.

Pág.52



12



Tiradores y manijas.

Pág.60



13



Correderas para cajón.

Pág.62



14

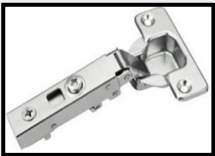

Bisagras para muebles.

Pág.68



15



Herramientas, grampas y clavillos.

Pág.72



16



Adhesivo profesional.

Pág.78



17



Herrajes de obra.

Pág.86



TAPACANTOS DE PVC
Y PREENCOLADOS.

01

FILO PVC BLANCO

- * Sin pegamento.
- * Se puede adquirir por rollo entero o fraccionado.



Valor sin iva.

	Fraccionado	X Rollo	
 Filo PVC Blanco 22 x 0.40 mm x mt Cantochap / 400122	\$ 129	\$ 120	(Rollo x 300 mts)
 Filo PVC Blanco 22 x 0.40 mm x mt Bronzen / TPC-30	\$ 118	\$ 109	(Rollo x 100 mts)
 Filo PVC Blanco 22 x 1 mm x mt Cantochap / 600122	\$ 296	\$ 276	(Rollo x 300 mts)
 Filo PVC Blanco 50 x 0.40 mm x mt Cantochap / 400145	\$ 377	\$ 351	(Rollo x 300 mts)
 Filo PVC Blanco 22 x 2 mm x rollo Cantochap / 500122		\$ 95.479	(Rollo x 150 mts)
 Filo PVC Blanco 22 x 2 mm x rollo Bronzen / TCP-31		\$ 61.283	(Rollo x 100 mts)

FILO PVC DE COLORES

Filo PVC **Colores** 22 x 0.40 mm x mt



	X Rollo	Valor sin iva.
 Filo PVC Colores 22 x 2 mm x Rollo de 150 mts / PVC2MM	\$ 150.864	



VOLVER AL INDICE

ADHESIVO TERMOFUSIBLE PARA MAQUINA



* Rango de temperatura de temperatura de 140°C - 165°C

Valor sin iva.

Adhesivo Hot Melt x 10 KG Kekol / **KF-20** \$ 75.588



* Rango de temperatura de temperatura de 190°C - 210°C

Valor sin iva.

Adhesivo Hot Melt x 10 KG Kekol / **KF-45** \$ 75.588



* Origen: Italia.

* Temperatura de aplicación 200°C

Valor sin iva.

Adhesivo Hot Melt Durante & Vivan x 25 KG / **DV25** \$ 233.188

Adhesivo Hot Melt Durante & Vivan x 5 KG / **DV05** \$ 49.093



FILO PVC PREENCOLADO

* Pvc con pegamento.

Valor sin iva.

Ancho 22 mm

X Rollo X 10 Rollos

Filo PVC preencolado Blanco x 50 mts / **2100** \$ 6.390 \$ 5.940



FILO MELAMINICO PREENCOLADO 22MM

Ancho 22 mm



Valor sin iva.

X Rollo X 10 Rollos

Filo Blanco 22 mm Bronzen x 50 mts / **TPC-21** \$ 10.092 \$ 9.382



Ancho 22 mm



Valor sin iva.

X Rollo X 10 Rollos

Filo Blanco 22 mm Cantochap x 50 mts / **20022** \$ 7.678 \$ 7.138

FILO MELAMINICO PREENCOLADO 50MM

Ancho 50 mm

BRONZEN°

Valor sin iva.

X Rollo X 9 Rollos

Filo Blanco 50 mm Bronzen x 50 mts / TPC-22 \$ 22.890 \$ 21.278

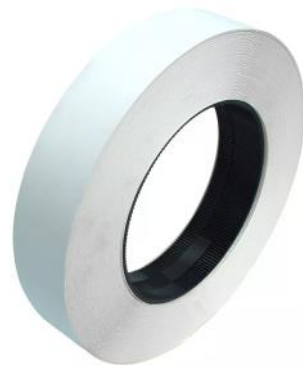

Ancho 50 mm

cantochap
calidad en tapacantos

Valor sin iva.

X Rollo X 9 Rollos

Filo Blanco 50 mm Cantochap x 50 mts / 200250 \$ 29.154 \$ 27.101



FILO MELAMINICO PREENCOLADO COLORES

22 Y 50 MM



Clic aquí

BRONZEN°

Valor sin iva.

Refilador de canto doble completo / TL-04 \$ 15.925

Repuestos de cuchillas completo / TL-05 \$ 5.492



FILO ENCHAPADO NATURAL

* Disponible en rollo de 50 mts.

Valor sin iva.

X Rollo X 10 Rollos

Filo paraíso natural sin pegamento 22x0.40 mm / M00422 \$ 13.315 \$ 12.378

Filo paraíso natural con pegamento 22x0.40 mm / M20422 \$ 22.155 \$ 20.594

Filo paraíso natural sin pegamento 50x0.40 mm / M00450 \$ 29.315 \$ 27.251

Filo guatambú natural sin pegamento 22 x 0.40 mm / M00622 \$ 13.315 \$ 12.378



VOLVER AL INDICE

FRENTES DE PLACARD Y SISTEMAS CORREDIZOS

02

KIT DE PLACARD COMPLETO

PERFILES

+

RUEDAS

+

ACCESORIOS

 **Clic aquí**



Aluminio hecho producto



PERFILERIA Y ACCESORIOS SUELTOS

Valor sin iva.

Perfil superior de placard x 2 mts	/	PFS2	\$ 12.179
Perfil superior de placard x 3 mts	/	PFS3	\$ 18.268
Perfil superior de placard x 4 mts	/	PFS4	\$ 24.357
Perfil superior de placard x 6 mts	/	PFS6	\$ 36.536



Valor sin iva.

Perfil inferior de placard x 2 mts	/	PFI2	\$ 4.254
Perfil inferior de placard x 3 mts	/	PFI3	\$ 6.381
Perfil inferior de placard x 4 mts	/	PFI4	\$ 8.508
Perfil inferior de placard x 6 mts	/	PFI6	\$ 12.762



Valor sin iva.

Perfil lateral de placard x 2.60 mts	/	PLP26	\$ 10.535
Perfil lateral de placard x 5.20 mts	/	PLP52	\$ 21.070
Felpa para perfil lateral x mt	/	FP	\$ 153



Valor sin iva.

Rueda inferior de placard	/	RP	\$ 2.394
---------------------------	---	-----------	----------



Valor sin iva.

Rueda superior de placard	/	PSR	\$ 605
---------------------------	---	------------	--------



VOLVER AL INDICE

Accesorio cierra suave Grupo Euro x par / FSC

Valor sin iva.

\$ 11.970



Perfil aluminio H de 18 mm para unión de placas x 3 mts / HU18

Valor sin iva.

\$ 4.698



Perfil transición madera a vidrio c/burlete x 3 mts

/ T18V

Valor sin iva.

\$ 17.094



Perfil transición perfil a vidrio c/burlete x 3 mts

/ TMV18

Valor sin iva.

\$ 17.094



SISTEMA CORREDIZO RUEDAMAS "D52"

Sistema para puertas corredizas de madera con desplazamiento al piso, para dos hojas.
Posee tope cruce de hojas que evita el traslape. Puede instalarse en puertas de madera o marco de aluminio. Se logra una luz mínima entra la puerta y el vano.

* Capacidad de carga 50 kg por hoja.

Sistema D52 Ruedamas para dos hojas / D52KIT

Valor sin iva.

\$ 12.176

Riel D52 inferior Ruedamas x 2 mts / D52RI2

\$ 5.089

Riel D52 superior Ruedamas x 2 mts / D52RS2

\$ 5.128

Riel D52 inferior Ruedamas x 3 mts / D52RI3

\$ 7.633

Riel D52 superior Ruedamas x 3 mts / D52RS3

\$ 7.692



FICHA TÉCNICA



SISTEMA CORREDIZO DUCASSE "D52"

DUCASSE
INDUSTRIAL

* Capacidad de carga 50 kg por hoja.

Valor sin iva.

Kit D52 x2 mts completo (para 2 hojas)	/	01-024	\$ 28.807
Kit D52 x3 mts completo (para 2 hojas)	/	01-025	\$ 39.326
Sistema D52, accesorios para dos hojas	/	01-002	\$ 7.426
Riel D52 Ducasse inferior x2 mts	/	07-008	\$ 5.665
Riel D52 Ducasse superior x2 mts	/	07-009	\$ 7.835
Riel D52 Ducasse inferior x3 mts	/	07-010	\$ 8.497
Riel D52 Ducasse superior x3 mts	/	07-011	\$ 11.752



FICHA TÉCNICA

SISTEMA CORREDIZO GRUPO EURO "GE52"

GRUPO
euro

Contiene un riel superior, un riel inferior y ruedas para dos hojas.

La manija MGE18 es un opcional. Se aplica en un solo extremo de la placa, porque si se pone en el medio se toca con la puerta de atrás. Para el lado interno se recomienda aplicar el tapacanto EURO18.

* Capacidad de carga 50 kg por hoja.

Valor sin iva.

Kit GE52 de 1.5 mts x 2 hojas (c/ ruedas)	/	GE52-150	\$ 28.922
Kit GE52 de 2 mts x 2 hojas (c/ ruedas)	/	GE52-200	\$ 32.295
Kit GE52 de 3 mts x 2 hojas (c/ ruedas)	/	GE52-300	\$ 39.429
Kit accesorios de 4 ruedas y 4 patines	/	GEA	\$ 14.893
Perfil manija GE52 p/18mm x 2.60 mts	/	MGE18	\$ 7.300



VIDEO

FICHA TÉCNICA

SISTEMA CORREDIZO RUEDAMAS D02K

MR+

* Capacidad de carga 15 kg por hoja.

Valor sin iva.

Sistema D02K para 2 hojas	/	D02K	\$ 2.139
---------------------------	---	-------------	----------

Componentes del set: Cuatro ruedas inferiores con bolillero y cuatro guías superiores.

FICHA TÉCNICA



VOLVER AL INDICE

* Capacidad de carga 10 kg por hoja.

Valor sin iva.

Rueda inferior D02	/	D02	\$ 399
Chapita superior D02	/	D02CH	\$ 118



SISTEMA CORREDIZO RUEDAMAS D10K

* Capacidad de carga 12 kg por hoja.

Valor sin iva.

Sistema D10K para 2 hojas	/	D10K	\$ 2.431
Guía de aluminio de embutir x 3 mts	/	D133	\$ 4.084



Componentes del set: Cuatro ruedas inferiores y cuatro guías superiores.

[FICHA TÉCNICA](#)

SISTEMA CORREDIZO OFFICE

Valor sin iva.

Sistema Office de 4 ruedas y 4 patines	/	KOA	\$ 6.011
Guía de Aluminio Office embutir x 3mts	/	GO	\$ 4.830



* Capacidad de carga 15 kg por hoja.



[FICHA TÉCNICA](#)

Contiene freno fin de carrera.

* Capacidad de carga 20 kg por hoja.

Valor sin iva.

Sistema D200 para dos hojas.	/	D200	\$ 9.623
Guía de aluminio de embutir x 3 mts	/	D133	\$ 4.084



[FICHA TÉCNICA](#)

Contiene freno fin de carrera.

* Capacidad de carga 20 kg por hoja.

Valor sin iva.

Sistema D210 Vidrio para 2 hojas	/	D210	\$ 12.547
Guía de aluminio de embutir x 3 mts	/	D133	\$ 4.084



PARA VIDRIO

[FICHA TÉCNICA](#)

SISTEMA CORREDIZO DUCASSE 1535

- * Contiene freno fin de carrera.
- * Capacidad de carga 15 kg por hoja.

Valor sin iva.

Set AI - 1535 (para dos hojas) Ducasse	/	01-006	\$	9.781
Riel embutido para sistema 1535 x 2 mts	/	07-057	\$	3.100
Riel embutido para sistema 1535 x 3 mts	/	07-058	\$	4.649

DUCASSE
INDUSTRIAL



SISTEMA CORREDIZO RUEDAMAS H53A

Sistema colgante que permite una libre circulación por el piso. Los carros se presentan con dos rodamientos, cuerpo de chapa y recubrimiento de baño de zinc. Rueda de poliamida con rodamiento a rulemán blindado de suave y muy silencioso desplazamiento.

- * Para placa de 15 a 30 mm de espesor.
- * Capacidad de carga 60 kg por hoja.

Valor sin iva.

Sistema colgante doble Ruedamas p/ dos hojas	/	H53A	\$	9.871
Riel galvanizado p/puerta colgante x2 mts	/	H504	\$	8.716
Riel galvanizado p/puerta colgante x3 mts	/	H505	\$	13.075



SISTEMA CORREDIZO DUCASSE DUCLOSET

- * Para placa de 15 a 30 mm de espesor.
- * Capacidad de carga de 30 (simple) y 45 kg (doble) por hoja.

Valor sin iva.

Sistema Ducloset simple (para dos hojas)	/	02-001	\$	5.107
Sistema Ducloset doble (para dos hojas)	/	02-002	\$	8.680
Riel U-20 acero zincado amarillo x2mts	/	06-001	\$	8.423
Riel U-20 acero zincado amarillo x3mts	/	06-002	\$	12.634

DUCASSE
INDUSTRIAL



SISTEMA CORREDIZO RUEDAMAS G38A

* Para placa mayor a 18 mm

* Capacidad de carga 90 kg por hoja.

Valor sin iva.

Sistema MR Plus 2.0 para una hoja	/	G38A	\$ 13.462
Riel MR Plus aluminio x2 mts	/	H02VA2	\$ 17.575
Riel MR Plus aluminio x3 mts	/	H02VA3	\$ 26.361

Opcionales:

Valor sin iva.

Soporte lateral a pared MR Plus x par	/	R26	\$ 1.609
Cenefa de aluminio MR Plus x 2 mts	/	RC2	\$ 8.658
Cenefa de aluminio MR Plus x 3 mts	/	RC3	\$ 12.936
Tapa cenefa MR Plus x par	/	R27	\$ 515



SISTEMA CORREDIZO GRUPO EURO SICCO

* Para placa mayor a 18 mm

* Capacidad de carga 60 kg por hoja.

Valor sin iva.

Kit Sicco Doble accesorios y riel x2 mts p/ una hoja	/	SD2	\$ 32.510
Kit Sicco Doble accesorios y riel x3 mts p/ una hoja	/	SD3	\$ 40.727

Opcionales:

Valor sin iva.

Accesorios Sicco Doble para hoja adicional	/	SDA	\$ 15.313
Cenefa de aluminio x2 mts	/	CC2	\$ 12.198
Cenefa de aluminio x3 mts	/	CC3	\$ 18.299
Tapa plástica para cenefa (x par)	/	TRDC	\$ 700
Soporte para fijación del riel a la pared	/	SSP	\$ 1.117



SISTEMA CORREDIZO DUCASSE DN80

DUCASSE
INDUSTRIAL

* Para placa mayor a 18 mm

Valor sin iva.

Kit Dn80 con freno x 2 mts (para una hoja) / **02-217** \$ 46.002

Kit Dn80 con freno x 3 mts (para una hoja) / **02-218** \$ 59.421

* El kit esta compuesto por un riel de aluminio U-21 y los carros para una puerta.

Opcionales:

Valor sin iva.

Sistema Dn80 con freno (para una hoja) / **02-011** \$ 15.103

Riel aluminio U-21 x 2mts / **07-003** \$ 38.917

Riel aluminio U-21 x 3mts / **07-004** \$ 58.375

Par de conector U-21 para agarrar al lateral / **07-041** \$ 5.307

Cenefa corta para riel U-21 x 2mts / **07-037** \$ 21.610

Cenefa corta para riel U-21 x 3mts / **07-038** \$ 32.415

Tapa lateral riel U-21 x par / **09-928** \$ 1.241

Tapa lateral riel U-21 para cenefa x par / **09-929** \$ 1.453

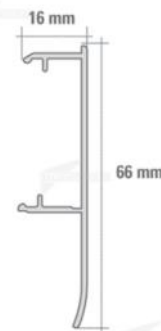

SISTEMA CORREDIZO KIT GRANERO

* Con rueda de 65 mm. montada sobre rulemán blindado que permite una carga de hasta 150 kg.

Valor sin iva.

Kit granero term. negro 1.80 mts / **KG18N** \$ 39.025

Kit granero term. negro 2.40 mts / **KG24N** \$ 46.065

Kit rodamientos para una hoja adicional / **KGHN** \$ 32.731



* El kit incluye todas las fijaciones y accesorios de armado, inclusive tres bisagras libro para unir las dos puertas.

* Apertura izquierda y derecha.

Valor sin iva.

Kit granero plegable term. negro x 1 mt. / **KGPL100N** \$ 39.310

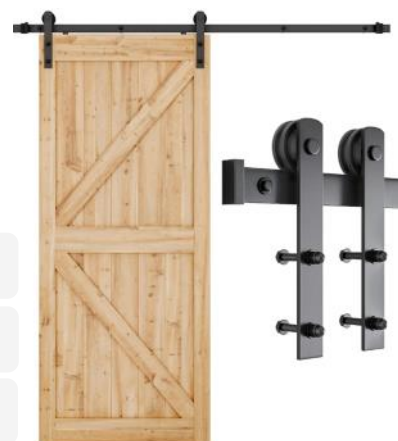

VOLVER AL INDICE

- * Para placa desde 15 a 36 mm
- * Sin necesidad de calar la puerta para colocar la cubeta.
- * Manijón de diámetro 25 mm x 300 mm de largo.
- * Cubeta de 45 mm x 160 mm

Valor sin iva.

Manijón con cubeta para puerta corrediza / **R02.012** \$ 16.979



SISTEMA CORREDIZO DUCASSE PL-2550

- * Capacidad de carga 20 kg por puerta.
- * Puede ser aplicado tanto en puertas que plieguen a derecha o izquierda.
- * Las puertas quedan sobrepuestas al vano, generando una imagen limpia
Ocultando herrajes y estructura del mueble.
- * Aplicable tanto a puertas de madera como con marco de aluminio en perfiles
de ancho mínimo 45 mm.

DUCASSE 
INDUSTRIAL



Valor sin iva.

Sistema plegable PL-2550 (para dos hojas) / **09-008** \$ 16.188

Riel de aluminio para PL-2550 x2 mts / **07-015** \$ 15.198

Riel de aluminio para PL-2550 x3 mts / **07-016** \$ 22.797



SISTEMAS CORREDIZO DUCASSE PLEGADUC

- * Capacidad de carga 15 kg por puerta.
- * Puede ser aplicado tanto en puertas que plieguen a derecha o izquierda.
- * Posee sistema de freno y retención, haciendo que las puertas
se mantengan cerradas.
- * Disponible para dos o cuatro puertas que abren para un mismo lado.

DUCASSE 
INDUSTRIAL



Valor sin iva.

Sistema plegable Plegaduc Pro (p/ dos hojas) / **253062** \$ 6.596

Sistema plegable Plegaduc Pro (p/ cuatro hojas) / **253012** \$ 12.038

Riel canal CD-50 aluminio x3 mts / **07-013** \$ 13.787



SISTEMAS CORREDIZO DUCASSE DN80-PL

- * Sistema plegable colgante para 2 y 4 puertas de 40 kg cada una.
- * Sistema de montaje no requiere de laterales en el vano.
- * Posibilidad de instalar dos set de 2 hojas en sentido opuesto en un mismo riel.
- * Requiere una guía inferior o ranura tipo "U" de 20 x 20 mm no incluida en el kit.

DUCASSE INDUSTRIAL

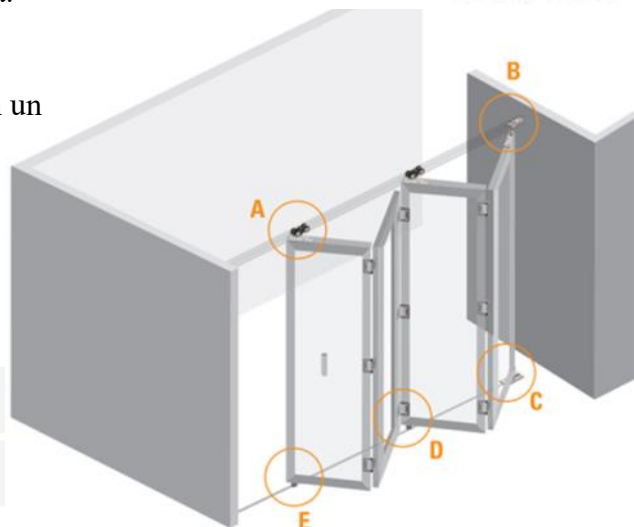

Valor sin iva.

Sistema plegadizo DN80-PL 2 hojas / **09-031** \$ 14.463

Sistema plegadizo DN80-PL 4 hojas / **09-032** \$ 48.600

Riel aluminio U-21 x 2 mts / **07-003** \$ 38.917

Riel aluminio U-21 x 3 mts / **07-004** \$ 58.375

FICHA TÉCNICA



TENSOR DE PUERTA

- * La instalación oculta hace una apariencia elegante.
- * Gran ajuste: Fácil regulación con ± 6 mm.
- * Uso universal: la varilla de 1000 mm se puede cortar al azar.
- * Aplica al espesor de puerta >15 mm; Altura de la puerta: 1000 mm-2700 mm.
- * El acero de alta resistencia hace un movimiento fuerte y constante.

TUTTI

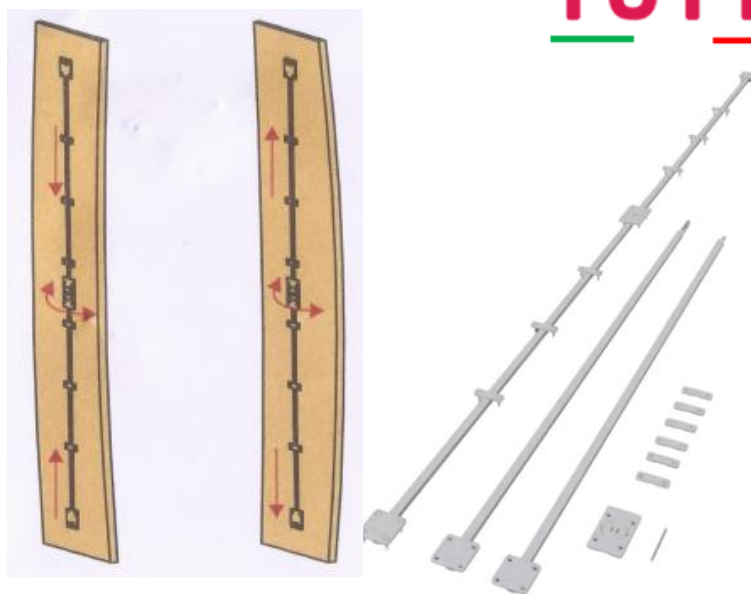

Valor sin iva.

Tensor de puerta Tutti / **T202** \$ 18.092

FICHA TÉCNICA



ILUMINACION LED PARA MUEBLES.



03

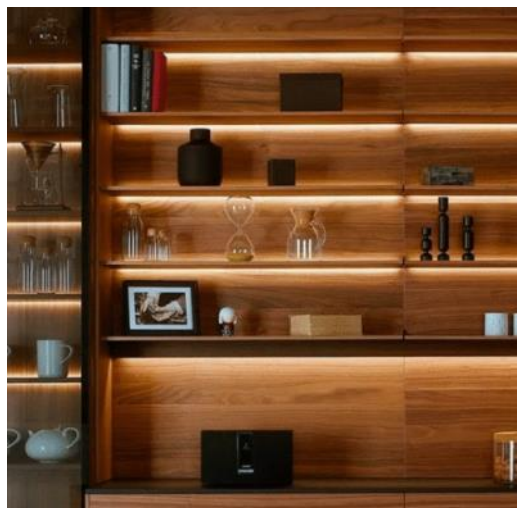

Valor sin iva.

Perfil led para embutir con difusor x 3 mts / **PLE** \$ 8.717

Perfil led negro para embutir con difusor x 3 mts / **PLEN** \$ 9.588

FICHA TÉCNICA



Valor sin iva.

Perfil led para aplicar con difusor x 3 mts / **PLC** \$ 7.607

Perfil led negro para aplicar con difusor x 3 mts / **PLCN** \$ 8.368

FICHA TÉCNICA



Valor sin iva.

Par de tapas para perfil PLC / **TLC** \$ 298

Par de tapas 45° para perfil PLC / **T45LC** \$ 298

Grampa para perfil PLC plano / **GLC** \$ 198

Grampa para perfil PLC a 45° / **G45LC** \$ 198

Par de tapas para perfil PLCN / **TLCN** \$ 326

Par de tapas 45° para perfil PLCN / **T45LCN** \$ 326



VARILLA LED DE APLICAR A 220V DIRECTO

* Conexión directa a 220V. Sin fuentes de alimentación.

* Disponible en luz fría y luz cálida.

Valor sin iva.

Varilla led de 80 cm luz fría / **VAR-80F** \$ 3.660

Varilla led de 100 cm luz fría / **VAR-100F** \$ 4.437

Varilla led de 120 cm luz fría / **VAR-120F** \$ 4.659

Varilla led de 80 cm luz cálida / **VAR-80C** \$ 3.660

Varilla led de 100 cm luz cálida / **VAR-100C** \$ 4.437

Varilla led de 120 cm luz cálida / **VAR-120C** \$ 4.659



KIT PERFIL LED CON SENSOR TOUCH

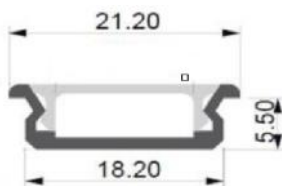

* Luz blanca fría o cálida de alta intensidad. (1600 lumens). Led 2835 . 120 Led por metro.

* Kit ya cableado y con fichas de conexión, no requiere armado.

* Sensor touch que cumple la función de interruptor y permite también regular la intensidad de la luz.

* Se aplica sobre el mueble a través de los soportes que vienen incluidos. Opcional, se puede embutir.

* Incluye la fuente de alimentación.

Valor sin iva.

Valor sin iva.

Kit LED x 40 cm luz fría / **KL40F** \$ 18.432

Kit LED x 40 cm luz cálida / **KL40C** \$ 18.432

Kit LED x 60 cm luz fría / **KL60F** \$ 20.730

Kit LED x 60 cm luz cálida / **KL60C** \$ 20.730

Kit LED x 80 cm luz fría / **KL80F** \$ 23.029

Kit LED x 80 cm luz cálida / **KL80C** \$ 23.029

Kit LED x 100 cm luz fría / **KL100F** \$ 25.326

Kit LED x 100 cm luz cálida / **KL100C** \$ 25.326

Kit LED x 120 cm luz fría / **KL120F** \$ 27.624

Kit LED x 120 cm luz cálida / **KL120C** \$ 27.624

Kit LED x 140 cm luz fría / **KL140F** \$ 31.668

Kit LED x 140 cm luz cálida / **KL140C** \$ 31.668

Kit LED x 160 cm luz fría / **KL160F** \$ 33.965

Kit LED x 160 cm luz cálida / **KL160C** \$ 33.965

Kit LED x 200 cm luz fría / **KL200F** \$ 38.562

Kit LED x 200 cm luz cálida / **KL200C** \$ 38.562

Kit LED x 300 cm luz fría / **KL300F** \$ 50.051

Kit LED x 300 cm luz cálida / **KL300C** \$ 50.051

VOLVER AL INDICE

ROLLO TIRA LED

Base 8 mm (para perfiles led):

Valor sin iva.

Rollo de tira led 2835 luz fría x5 mts. Base 8mm / **RLF** \$ 13.970

Rollo de tira led 2835 luz cálida x5 mts. Base 8mm / **RLC** \$ 13.970



Base 5 mm (para caño oval aluminio):

Valor sin iva.

Rollo de tira led 2835 luz fría x5 mts. Base 5mm / **RLF5** \$ 13.970

Rollo de tira led 2835 luz cálida x5 mts. Base 5mm / **RLC5** \$ 13.970



* Ver caño en página N°

* Se recomienda fuente de 1 amp. por cada metro de led.

Valor sin iva.

Fuente de alimentación 1 amp / **FA1** \$ 4.637

Fuente de alimentación 2 amp / **FA2** \$ 6.203

Fuente de alimentación 5 amp / **FA5** \$ 15.359



**PUERTAS DE
ALUMINIO / VIDRIO**



04



PUERTAS DE ALUMINIO Y VIDRIO ARMADAS A MEDIDA

Fabricamos puertas de aluminio y vidrio.

Contamos con una variedad de mas de diez modelos de perfiles y distintos tipos de vidrios para combinar, asegurando una excelente terminación y calidad.



PERFILERIA DE ALUMINIO PARA ARMAR PUERTAS



Valor sin iva.

Perfil para puerta "TOP" x3 mts	/ TOP	\$ 25.752
Perfil "TOP" x3 mts por paquete de 8 tiras		\$ 23.939



FICHA TÉCNICA



VOLVER AL INDICE



Aluminio hecho producto

Valor sin iva.

Perfil para puerta "CITY" x3 mts / **CITY** \$ 25.752

Perfil "CITY" x3 mts por paquete de 10 tiras \$ 23.939

FICHA TÉCNICA



Valor sin iva.

Perfil para puerta "ZENIT" x3 mts / **ZENIT** \$ 25.752

Perfil "ZENIT" x3 mts por paquete de 10 tiras \$ 23.939

FICHA TÉCNICA



Valor sin iva.

Perfil para puerta "INTER" x3 mts / **INTER** \$ 25.752

Perfil "INTER" x3 mts por paquete de 8 tiras \$ 23.939

FICHA TÉCNICA



Valor sin iva.

Perfil para puerta "SIERRA" x3 mts / **SIERRA** \$ 25.752

Perfil "SIERRA" x3 mts por paquete de 8 tiras \$ 23.939

FICHA TÉCNICA



Valor sin iva.

Perfil para puerta "SIERRA PULIDO" x3 mts / **SIERRAP** \$ 32.355

Perfil "SIERRA PULIDO" x3 mts por paquete de 8 tiras \$ 30.076

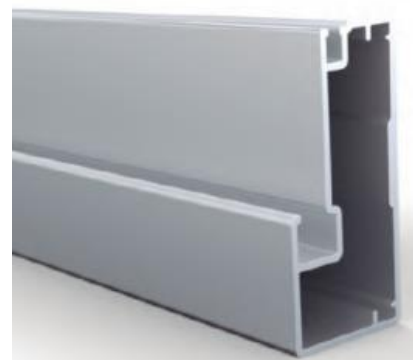



Aluminio hecho producto

Valor sin iva.

Perfil para puerta "SIERRA NEGRO" x3 mts / **SIERRAN** \$ 25.752

Perfil "SIERRA NEGRO" x3 mts por paquete de 8 tiras \$ 23.939



Valor sin iva.

Perfil para puerta "SIERRA BLANCO" x3 mts / **SIERRAB** \$ 25.752

Perfil "SIERRA BLANCO" x3 mts por paquete de 8 tiras \$ 23.939



* Para todos los modelos de perfiles.

Valor sin iva.

Escuadra 2045 con tornillos / **ES2045** \$ 1.115



* Escuadra modelo "armado fácil" para perfil ZENIT

Valor sin iva.

Escuadra doble armado fácil Zenit / **ES2047AR** \$ 1.947

* Escuadra modelo "armado fácil" para el resto de perfiles.

Valor sin iva.

Escuadra doble armado fácil / **ES2045AR** \$ 1.947



* Incluye mechas para escuadras.

Valor sin iva.

Matriz perforación de escuadras / **MTZ-P** \$ 139.248



Valor sin iva.

Copa perforación de bisagras / **CP35** \$ 59.686



ESTANTERIAS MODULARES

05



Estructuras de caño cuadrado, con terminación epoxi microtexturada negra.

Disponibles en 4 versiones que te permiten diseñar tu mueble.

Solo ténes que agregar los estantes. Incluye tarugos y tornillos de fijación.

Valor sin iva.

Modular 480 x unidad / **MOD11** \$ 20.733

Altura : 480 mm
Caños: 20 X 20 mm
Profundidad: 400 mm
Profundidad interna: 358 mm
Altura entre estantes: 360 mm



Valor sin iva.

Modular 940 x unidad / **MOD21** \$ 33.390

Altura : 940 mm
Caños: 20 X 20 mm
Profundidad: 400 mm
Profundidad interna: 358 mm
Altura entre estantes: 360 mm



Valor sin iva.

Modular 1700 x unidad / **MOD31** \$ 51.074

Altura : 1700 mm
Caños: 20 X 20 mm
Profundidad: 400 mm
Profundidad interna: 358 mm
Altura entre estantes: 360 mm



Valor sin iva.

Modular 1540 x unidad / **MODG1** \$ 52.894

Altura : 1540 mm
Caños: **40** X 20 mm
Profundidad: 400 mm
Profundidad interna: 358 mm
Altura entre estantes: 360 mm

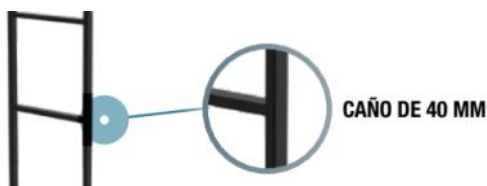

TORNILLOS, PUNTAS Y TARUGOS.



06

TORNILLO PHILLIPS DORADO



 [Clic aquí](#)

TORNILLO DRYWALL NEGRO



 [Clic aquí](#)

AVELLANADOR DE WIDIA BARIGUI

Valor sin iva.

Avellanador de 2.8 mm (diam. interno 2.8 / externo 8mm) /AV28 \$ 13.675

Avellanador de 3.0 mm (diam. interno 3.0 / externo 8mm) /AV30 \$ 13.675

Avellanador de 4.0 mm (diam. interno 4.0 / externo 8mm) /AV40 \$ 13.675



SACABOCADOS PARA TAPA TORNILLOS

Valor sin iva.

Sacabocados para tapa tornillos 8 mm Barigui / SBB8 \$ 22.774



TAPA TORNILLOS AUTOADHESIVOS

Valor sin iva.

Tapa tornillos blanco *plancha x 96 unid.* / TT1 \$ 1.376

Por paquete de 10 planchas color blanco \$ 1.280

Tapa tornillos colores *plancha x 50 unid.* / TT2 \$ 893

Por paquete de 10 planchas del mismo color \$ 830





Valor sin iva.

Embelecedor para tornillo niquelado D.12 mm / **EMB12** \$ 374

Embelecedor para tornillo niquelado D.14 mm / **EMB14** \$ 440

Embelecedor para tornillo niquelado D.16 mm / **EMB16** \$ 528

PUNTAS Y ADAPTADOR MAGNETICO

Valor sin iva.

Punta Phillips N° 2 corta 25 mm / **PH2C** \$ 444

Punta Phillips N° 2 larga 50 mm / **PH2L** \$ 622

Punta Phillips N° 1 larga 50 mm / **PH1L** \$ 622

Adaptador magnético / **50-038** \$ 1.641



TARUGOS

Valor sin iva.

GRUPO KH

		Pack x 500	Pack x 1000
Tarugo plástico universal N° 6	/ TFN6	\$ 20	\$ 18
Tarugo plástico universal N° 8	/ TFN8	\$ 35	\$ 33
Tarugo plástico universal N° 10	/ TFN10	\$ 68	\$ 63



Valor sin iva.

Caja tarugo SX N°6 x 100 unidades / **608906** \$ 3.182

Caja tarugo SX N°8 x 100 unidades / **608908** \$ 5.978

Caja tarugo SX N°10 x 50 unidades / **608910** \$ 5.358



		Valor sin iva.
Caja tarugo S N° 6 x 100 unidades	/ 608006	\$ 2.178
Caja tarugo S N° 8 x 100 unidades	/ 608008	\$ 4.161
		Valor sin iva.
Caja tarugo SA N° 6 x 100 unidades	/ 608206	\$ 2.449
Caja tarugo SA N° 8 x 100 unidades	/ 608208	\$ 4.491



		Valor sin iva.
Bolsa kit tarugo SX N°6 + tornillo 4.5 x 35 x 100u	/ 608166	\$ 9.183
Bolsa kit tarugo SX N°8 + tornillo 5.0 x 45 x 100u	/ 608168	\$ 16.061
		Valor sin iva.
Bolsa kit tarugo S N°6 + tornillo 4.5 x 35 x 100u	/ 608156	\$ 6.581
Bolsa kit tarugo S N°8 + tornillo 5.0 x 45 x 100u	/ 608158	\$ 11.527



		Valor sin iva.
Balde tarugo SX N°6 x 1800 unidades	/ 616283	\$ 36.170
Balde tarugo SX N°8 x 800 unidades	/ 616290	\$ 35.417



		Valor sin iva.
Tarugo para yeso/ Durlock GK x 100 unidades.	/ 608511	\$ 7.667



		Valor sin iva.
Tarugo para yeso/ Durlock GK-A Autoperforante x 100u.	/ 608521	\$ 6.969



PERFILES Y TAPA ANTOS DE ALUMINIO



07

TAPACANTOS DE ALUMINIO



 [Clic aquí](#)

PERFILES INTERNO TIPO GOLA



 [Clic aquí](#)

PERFILES MANIJAS



 [Clic aquí](#)

ZOCALOS DE ALUMINIO



 [Clic aquí](#)

PERFIL OCULTO MOA



Valor sin iva.

X Unidad x 10 unid.

Manija oculta para alacena con felpa x 3 mts / **MOA** \$ 17.283 \$ 16.066

Manija oculta negra para alacena con felpa x 3 mts / **MOAN** \$ 17.283 \$ 16.066

[FICHA TÉCNICA](#)

[VOLVER AL INDICE](#)



Valor sin iva.

X Unidad x 10 unid.

Perfil conector estructural con felpa x 3 mts / **CE** \$ 26.242 \$ 24.394

Par de fijación conector estructural con tornillos / **FCE** \$ 1.849

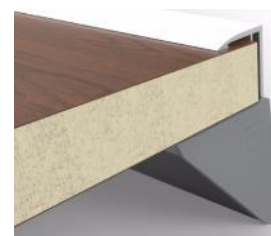

Valor sin iva.

X Unidad x 10 unid.

Perfil de estante para placa de 18 mm x 3 mts / **SE18** \$ 29.558 \$ 27.476

Tapa plástica para terminación por par / **TSE** \$ 1.123



Valor sin iva.

Angulo "L" 12.7 x 12.7 mm anod. natural x 3 mts / **L12** \$ 5.977

Angulo "L" 18 x 18 mm anod. natural x 3 mts / **L18** \$ 6.569

Angulo "L" 25 x 25 mm anod. natural x 3 mts / **L25** \$ 10.376



Valor sin iva.

Moldura aluminio anod. natural x tira 3 mts / **MPM** \$ 5.738



Valor sin iva.

Perfil plano 19 x 2 mm anod. natural x 3 mts / **P19** \$ 5.253

Perfil plano 19 x 2 mm negro x 3 mts / **P19N** \$ 5.253

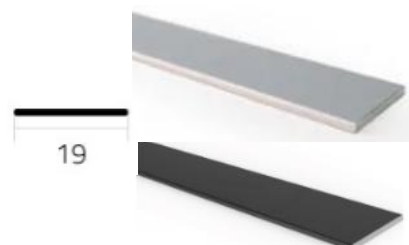

VOLVER AL INDICE

ACCESORIOS DE
ARMADO.

08

		Valor sin iva.
Topes autoadhesivos 3 mm x 100 u.	/ F-610	\$ 2.456
		Valor sin iva.
Reten "push to open" plástico para aplicar	/ PO-P	\$ 700
		Valor sin iva.
Reten "push to open" plástico para embutir	/ PO-E	\$ 967
		Valor sin iva.
Reten "push to open" metálico para aplicar	/ PO-M	\$ 1.000
		Valor sin iva.
Reten a rodillos zincado	/ RR	\$ 291
		Valor sin iva.
Imán para puerta 30 mm blanco	/ IM-30-B	\$ 198
Imán para puerta 50 mm blanco	/ IM-50-B	\$ 440
		Valor sin iva.
Imán para puerta extrachato 40 mm	/ IM-40	\$ 769
		Valor sin iva.
Tarugo de madera 6x30 x 1000 u.	/ TM6X30	\$ 12.688
Tarugo de madera 8x30 x 1000 u.	/ TM8X30	\$ 11.162
Tarugo de madera 8x35 x 1000 u.	/ TM8X35	\$ 14.271
Tarugo de madera 8x40 x 1000 u.	/ TM8X40	\$ 14.463
Tarugo de madera 8x50 x 1000 u.	/ TM8X50	\$ 18.894
Tarugo de madera 10x50 x 1000 u.	/ TM10X50	\$ 21.741
Tarugo de madera 12x50 x 1000 u.	/ TM12X50	\$ 37.609



Valor sin iva.

Soporte de estante zincado x 500 u / **F-6-500** \$ 8.298

Soporte de estante zincado x 1000 u / **F-6-1000** \$ 15.711



Valor sin iva.

Soporte de estante metálico niquelado / **2600N** \$ 90



Valor sin iva.

Soporte de estante 5 mm blanco x 100 u / **SOPBL** \$ 3.652

Soporte de estante 5 mm transparente x 100 u. / **SOPTR** \$ 3.652



Valor sin iva.

Soporte para vidrio hasta 6 mm / **2900** \$ 479

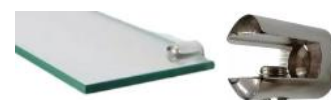

Valor sin iva.

Soporte para vidrio con ventosa / **SOPV** \$ 137



Valor sin iva.

Escuadra plástica blanca con tapita x 100 u. / **TPB** \$ 2.201

Escuadra plástica negra con tapita x 100 u. / **TPN** \$ 2.201

Escuadra plástica transparente con tapita x 100 u. / **TPT** \$ 2.201



Valor sin iva.

Colgador de alacena regulable blanco / **0012** \$ 467

Colgador de alacena regulable negro / **0012N** \$ 467



HÄFELE

Valor sin iva.

Colgador de armario regulable / **290.00.740** \$ 2.420

Placa de suspensión 60 mm / **290.08.900** \$ 764



Valor sin iva.

X unid. X pack 200 u.

Escuadra plana 900 mm x 900 mm	/	EPZ	\$ 225	\$ 210
--------------------------------	---	------------	--------	--------



Valor sin iva.

X unid. X pack 150 u.

Escuadra con alas zincada	/	EAZ	\$ 315	\$ 294
---------------------------	---	------------	--------	--------

Escuadra con alas blanca	/	EAB	\$ 360	\$ 336
--------------------------	---	------------	--------	--------

Escuadra con alas negra	/	EAN	\$ 360	\$ 336
-------------------------	---	------------	--------	--------



Valor sin iva.

X unid. X pack 500 u.

Escuadra de armar 16 x 33 mm	/	1633Z	\$ 155	\$ 144
------------------------------	---	--------------	--------	--------



Valor sin iva.

X unid. X pack 500 u.

Escuadra de armar 40 x 30 mm zincada	/	4030Z	\$ 180	\$ 168
--------------------------------------	---	--------------	--------	--------

Escuadra de armar 40 x 30 mm Blanco	/	4030B	\$ 240	\$ 224
-------------------------------------	---	--------------	--------	--------

Escuadra de armar 40 x 30 mm negra	/	4030N	\$ 240	\$ 224
------------------------------------	---	--------------	--------	--------



Valor sin iva.

X unid. X pack 200 u.

Escuadra de armar plástica doble blanca	/	EADB	\$ 157	\$ 146
---	---	-------------	--------	--------

Escuadra de armar plástica doble negra	/	EADN	\$ 157	\$ 146
--	---	-------------	--------	--------



Valor sin iva.

X unid. X pack 500 u.

Escuadra de armar 80 x 30 mm zincada	/	8030Z	\$ 609	\$ 566
--------------------------------------	---	--------------	--------	--------

Escuadra de armar 80 x 30 mm Blanco	/	8030B	\$ 692	\$ 643
-------------------------------------	---	--------------	--------	--------

Escuadra de armar 80 x 30 mm negra	/	8030N	\$ 692	\$ 643
------------------------------------	---	--------------	--------	--------



Valor sin iva.

X unid. X pack 50 u.

Chapa 80 x 60 plana, zincada	/	8060P	\$ 553	\$ 515
------------------------------	---	--------------	--------	--------



SISTEMA MINIFIX Y RAFIX



 [Clic aquí](#)

		Valor sin iva.
Herraje de unión de dos piezas blanco	/ F-40	\$ 340

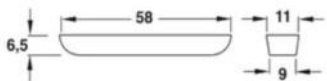

		Valor sin iva.	
		X unid.	X pack 500 u.
			
Patín antideslizante para clavar blanco	/ 650.12.710	\$ 87	\$ 81
Patín antideslizante para clavar negro	/ 650.12.310	\$ 87	\$ 81

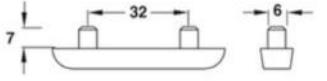

		Valor sin iva.	
		X unid.	X pack 500 u.
			
Patín antideslizante con tarugos blanco	/ 650.12.700	\$ 87	\$ 81
Patín antideslizante con tarugos negro	/ 650.12.300	\$ 87	\$ 81



		Valor sin iva.	
		X unid.	X pack 1000 u.
			
Patín simple con clavo diam. 16 mm blanco	/ F-316	\$ 17	\$ 16
		X unid.	X pack 500 u.
Patín doble con clavo 45x18 mm blanco	/ F-118	\$ 70	\$ 66



		Valor sin iva.	
		X unid.	X pack 100 u.
			
Patín simple con clavo diam. 10 mm blanco	/ 650.02.100	\$ 117	\$ 109
Patín simple con clavo diam. 15 mm blanco	/ 650.02.165	\$ 130	\$ 121
Patín doble con clavos 44x19 mm blanco	/ 650.05.718	\$ 271	\$ 252



		Valor sin iva.
Base plástica para placa 18 mm negro	/ BP18	\$ 18



VOLVER AL INDICE

* Ménsula de diámetro hexagonal 10 mm.

* Kit con arandela y tarugo Fischer SX10.

Valor sin iva.

X unid. X pack 20 u.

Soporte oculto x 12 cm	/ SO12	\$ 2.071	\$ 1.925
Soporte oculto x 17 cm	/ SO17	\$ 2.378	\$ 2.210
Soporte oculto x 23 cm	/ SO23	\$ 2.879	\$ 2.676



* Color epoxi negra.

* Ancho: 38.1 mm.

* Espesor: 3.2 mm.

Valor sin iva.

Ménsula industrial para estante 150 mm	/ M2.15N	\$ 2.363
Ménsula industrial para estante 200 mm	/ M2.20N	\$ 2.711
Ménsula industrial para estante 250 mm	/ M2.25N	\$ 3.019
Ménsula industrial para estante 300 mm	/ M2.30N	\$ 3.322



Valor sin iva.

Ménsula rebatible x par 8"	/ MR-08	\$ 4.430
Ménsula rebatible x par 10"	/ MR-10	\$ 5.839
Ménsula rebatible x par 12"	/ MR-12	\$ 6.443
Ménsula rebatible x par 14"	/ MR-14	\$ 7.853



Valor sin iva.

X unid. X pack 12 u.

Cerradura de arrimar cuadrada	/ BRZ-1100	\$ 1.051	\$ 977
-------------------------------	-------------------	----------	--------



X unid. X pack 12 u.

Cerradura de empuje	/ BRZ-1108	\$ 1.769	\$ 1.644
---------------------	-------------------	----------	----------



Valor sin iva.

Cerradura frontal c/ varilla 600 mm	/ C288-160	\$ 3.577
-------------------------------------	-------------------	----------



Valor sin iva.

Pasador de arrimar 65 mm zincado amarillo / **PAS01** \$ 226



Valor sin iva.

Pasa cable de 60 mm Negro / **FXH01** \$ 126



Pasa cable de 60 mm blanco / **FXH02** \$ 142

Valor sin iva.

Pasa cable cuadrado giratorio 60 mm negro / **PC-260N** \$ 589



Pasa cable cuadrado giratorio 60 mm blanco / **PC-260B** \$ 589

Valor sin iva.

Pasa cable USB de 60 mm / **PC-500** \$ 10.776



Valor sin iva.

Pasa cable rectangular con cepillo 160 x 80 mm / **PC-380-G** \$ 1.044



Valor sin iva.

Regatón diámetro 17 mm / **REG17** \$ 255 X unid. \$ 238 X pack 100u.



Regatón diámetro 32 mm / **REG32** \$ 268 X unid. \$ 249 X pack 100u.

X unid. X pack 100u.

Soporte oval para regatón / **SREGO** \$ 210 X unid. \$ 195 X pack 100u.



X unid. X pack 100u.

Soporte cuadrado para regatón / **SREGC** \$ 314 X unid. \$ 292 X pack 100u.



X unid. X pack 100u.

Soporte U-18 para regatón / **SREG18** \$ 530 X unid. \$ 493 X pack 100u.



* Profundidad 400 mm

Valor sin iva.

Fichero simple 412 mm	/ 5041	\$ 22.140
Fichero doble 862 mm	/ 5042	\$ 33.719



PISTONES A GAS



[Clic aquí](#)

- * Permite el cierre suave y controlado.
- * Ideal para cuando hay poco espacio como para colocar un pistón a gas.
- * Regulación de fuerza de cierre mediante un tornillo de presión.

Valor sin iva.

X unid. X pack 10 u.

Brazo cierre automático derecho	/ P-52-D	\$ 6.919	\$ 6.432
Brazo cierre automático izquierdo	/ P-52-I	\$ 6.919	\$ 6.432



- * Cierra suave.
- * Para alto de puerta de 400-500 mm
- * Para ancho de puerta de 800-1200 mm
- * Peso de la puerta de 5 a 6 KG

Valor sin iva.

Sistema elevable Free Flap Haits (por par)	/ HT-05.061	\$ 49.842
--	-------------	-----------

VOLVER AL INDICE



- * Cierra suave.
- * Para alto total de puerta de 600-800 mm
- * Para ancho de puerta de 700-800 mm
- * Peso de la puerta de 5 a 8 KG



Valor sin iva.

Sistema elevable y plegable Haits / HT-05.062

\$ 92.016

SISTEMAS DE APERTURA HAFELE



Trabajamos todos los sistemas de apertura para puerta de la marca Hafele.

Si es de su interés solicítenos el catálogo para poder seleccionar el sistema que le es más conveniente y así poder brindar cotización y asesoramiento.

Bisagra elevable 38 cm x par

/ MR-55

Valor sin iva.

\$ 15.157



Plato giratorio 20 x 20 para mesa de TV

/ PG-50

Valor sin iva.

\$ 1.443



VOLVER AL INDICE

**PATAS Y RUEDAS
PARA MUEBLES.**



09

PATAS PARA MUEBLES



 [Clic aquí](#)

RUEDAS PARA MUEBLES



 [Clic aquí](#)

ACCESORIOS DE COCINA.



10

PORTA RESIDUOS



 [Clic aquí](#)

CUBIERTEROS



 [Clic aquí](#)

DESPENSAS BAJO MESADA



 [Clic aquí](#)

[VOLVER AL INDICE](#)

Columnas extraíbles

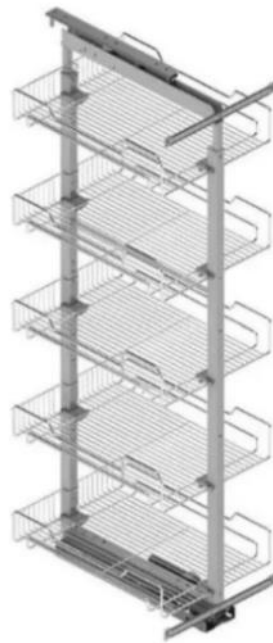
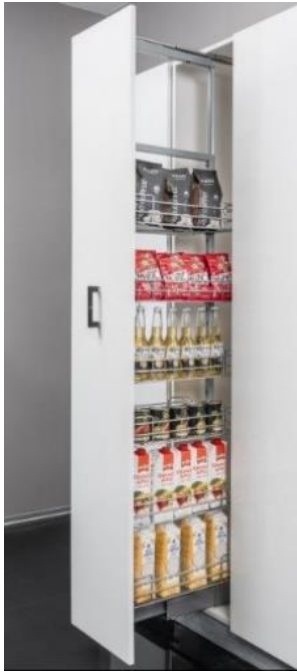

Accesorios rinconeros





* Con corredera telescópicas.

* Profundidad de 500 mm.

* Altura de 140 mm.

Valor sin iva.



Canasto bajo bacha con hueco ancho de 764 mm / **5058** \$ 79.047

Canasto bajo bacha con hueco ancho de 864 mm / **5060** \$ 83.007

Canasto bajo bacha con hueco ancho de 964 mm / **5062** \$ 92.479

Canasto bajo bacha con hueco ancho de 1064 mm / **5064** \$ 104.352

Canasto bajo bacha con hueco ancho de 1164 mm / **5066** \$ 125.665

* Con corredera telescópicas.

* Profundidad de 500 mm.

* Altura de 140 mm.

Valor sin iva.



Canasto bajo bacha entero ancho de 764 mm / **5059** \$ 79.047

Canasto bajo bacha entero ancho de 864 mm / **5061** \$ 83.007

Canasto bajo bacha entero ancho de 964 mm / **5063** \$ 92.479

Canasto bajo bacha entero ancho de 1064 mm / **5065** \$ 104.352

Canasto bajo bacha entero ancho de 1164 mm / **5067** \$ 125.665

* Con corredera telescópicas.

* Profundidad de 450 mm.

* Altura de 150 mm.

Valor sin iva.



Canasto cajón cromado ancho de 355 mm / **5000/C** \$ 39.468

Canasto cajón cromado ancho de 405 mm / **5001/C** \$ 40.437

Canasto cajón cromado ancho de 445 mm / **5002/C** \$ 44.135

Canasto cajón cromado ancho de 505 mm / **5003/C** \$ 44.620

* Altura 450 mm

* Profundidad 340 mm

Valor sin iva.

Canasto canguro de 250 mm de frente / **3004** \$ 13.479

Canasto canguro de 350 mm de frente / **3005** \$ 16.017



Valor sin iva.

Piso de aluminio c/burlete para módulo de 60 cm / PAM60	\$ 18.874
Piso de aluminio c/burlete para módulo de 80 cm / PAM80	\$ 24.435
Piso de aluminio c/burlete para módulo de 90 cm / PAM90	\$ 27.288
Piso de aluminio c/burlete para módulo de 100 cm / PAM100	\$ 30.142
Piso de aluminio c/burlete para módulo de 120 cm / PAM120	\$ 35.693

DiMOL



Valor sin iva.

Piso de PVC alto impacto para módulo de 60 cm / PS60G	\$ 8.520
Piso de PVC alto impacto para módulo de 80 cm / PS80G	\$ 8.946
Piso de PVC alto impacto para módulo de 90 cm / PS90G	\$ 9.940
Piso de PVC alto impacto para módulo de 100 cm / PS100G	\$ 10.792
Piso de PVC alto impacto para módulo de 120 cm / PS120G	\$ 11.644



Valor sin iva.

Escurreplatos de alacena acero inox. Módulo de 60cm / LC-560	\$ 29.977
Escurreplatos de alacena acero inox. Módulo de 80cm / LC-580	\$ 37.971
Escurreplatos de alacena acero inox. Módulo de 90cm / LC-590	\$ 41.968

BRONZEN°



Valor sin iva.

Elevador de alacena Tutti módulo de 600 mm / 71060	\$ 316.696
Elevador de alacena Tutti módulo de 800 mm / 71080	\$ 327.682

TUTTI

- * Elevador de alacena extraíble.
- * Terminación en cromado.
- * Con sistema cierra suave.

- * Medidas para módulo de 60cm : Ancho 564 mm. Prof. 268mm. Alto 555mm
- * Medidas para módulo de 80cm : Ancho 764 mm. Prof. 268mm. Alto 555mm



FICHA TÉCNICA



VOLVER AL INDICE

Valor sin iva.

Porta copa recto cromado 250 mm / **4030/A** \$ 3.706

Porta copa recto cromado 420 mm / **4030** \$ 4.412



Valor sin iva.

Soporte escobero metálico / **SE-02** \$ 2.336



Valor sin iva.

Destapador open negro / **3510NG** \$ 922

Destapador open blanco / **3510BL** \$ 922

Destapador open bronce viejo / **3510BV** \$ 922

Destapador open cobre viejo / **3510CV** \$ 922

Destapador open plata vieja / **3510PV** \$ 922



Valor sin iva.

Rejilla de ventilación aluminio anod. 225 x 80 mm / **RV-225-A** \$ 3.048

Rejilla de ventilación aluminio anod. 357 x 80 mm / **RV-357-A** \$ 5.025



* Rollo de 500 mm de ancho por 2000 mm de largo

Valor sin iva.

Alfombra gris gofrada antideslizante x rollo / **ALF-120-G** \$ 6.315

Alfombra blanca gofrada antideslizante x rollo / **ALF-120-B** \$ 6.315



ACCESORIOS DE PLACARD.



11

PANTALONEROS

* Corredera telescópica 450 mm

* 12 perchas de diámetro 5 mm

Valor sin iva.

Pantalonero lateral extraíble cromado / 3016 \$ 49.700



* Corredera telescópica 400 mm

* 10 perchas de diámetro 6 mm

Valor sin iva.

Pantalonero central extraíble cromado / 149 \$ 40.020

Pantalonero central extraíble negro / 149N \$ 24.457



* Corredera con sistema **cierra suave** de 450 mm

* 10 perchas de diámetro 6 mm

Valor sin iva.

Pantalonero central soft closing / 9351205 \$ 115.049

STARAX
yaşam kaliteniz...



* Corredera oculta con sistema **cierra suave**

* Material aluminio.

* Color gris perlado.

Medidas: 564 x 420 x 56 mm

Valor sin iva.

Pantalonero extraíble Tutti mod. de 600 mm / 10756 \$ 90.120

Medidas: 764 x 420 x 56 mm

Valor sin iva.

Pantalonero extraíble Tutti mod. de 800 mm / 10776 \$ 109.868

TUTTI



FICHA TÉCNICA



CANASTO DE ALMACENAMIENTO

- * Corredera oculta con sistema **cierra suave**
- * Material aluminio.
- * Color gris perlado.
- * Canasto desmontable.

Medidas: 564 x 420 x 140 mm

Valor sin iva.

Canasto cajón desmontable mod. de 600 mm / **10256** \$ 137.437

Medidas: 764 x 420 x 140 mm

Valor sin iva.

Canasto cajón desmontable mod. de 800 mm / **10276** \$ 153.836

TUTTI



FICHA TÉCNICA



BOTINEROS / ZAPATEROS

- * Corredera oculta con sistema **cierra suave**
- * Material aluminio.
- * Color gris perlado.
- * Canasto desmontable.

Medidas: 564 x 420 x 160 mm

Valor sin iva.

Botinero extraíble Tutti módulo 600 mm / **10556** \$ 152.992

Medidas: 764 x 420 x 160 mm

Valor sin iva.

Botinero extraíble Tutti módulo 800 mm / **10576** \$ 178.183

TUTTI



FICHA TÉCNICA



- * Corredera oculta con sistema **cierra suave**
- * Medidas: 325 mm ancho x 475 mm prof. x 1000 mm

Valor sin iva.

Botinero lateral izquierdo / **9351184** \$ 294.457

Botinero lateral derecho / **9351186** \$ 294.457

STARAX
yaşam kaliteniz...



VOLVER AL INDICE

ZAPATERO / BOTINERO GIRATORIO 360°

TUTTI

- * Zapatero giratorio 360°
- * Terminación gris perlado con bandeja marrón.
- * Para módulo de 800 mm



Medidas: 715 x 360 mm (1415 - 1525 mm)

Valor sin iva.

Zapatero giratorio Tutti 8 bandejas / **10C08H** \$ 478.321

Medidas: 715 x 360 mm (1965 - 2065 mm)

Valor sin iva.

Zapatero giratorio Tutti 12 bandejas / **10C12H** \$ 593.694

FICHA TÉCNICA



- * Alto 250 mm
- * Profundidad 500 mm
- * Regulable en ancho

Valor sin iva.

Botinero extraíble regulable cromado 440-580mm / **3013/B** \$ 73.278

Botinero extraíble regulable cromado 760-900mm / **3013/D** \$ 79.671

INDUSTRIAS
FARK



- * Corredera de 450 mm
- * Peines cromados
- * Ancho de 8 pares (390 mm)
- * Ancho de 12 pares (610 mm)

Valor sin iva.

Botinero de peines cromados 8 pares / **3010/B** \$ 31.798

Botinero de peines cromados 12 pares / **3012/B** \$ 40.075



VOLVER AL INDICE

Valor sin iva.

Bisagra Plástica para armar botineros x par / **BBOT** \$ 1.491



JOYERO O ALHAJERO EXTRAIBLE

- * Corredera oculta con sistema **cierra suave**
- * Material aluminio.
- * Color gris perlado.
- * Interior cubierto en pana gris.

TUTTI

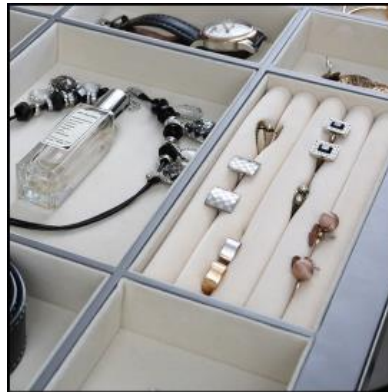

Medidas: 564 x 420 x 61 mm

Valor sin iva.

Alhajero extraíble Tutti módulo 600 mm / **10856** \$ 171.208

Medidas: 764 x 420 x 61 mm

Valor sin iva.

Alhajero extraíble Tutti módulo 800 mm / **10876** \$ 192.060

FICHA TÉCNICA



PERCHERO REBATIBLE

- * Sistema hidráulico.
- * Regulable de 600 a 830 mm y 830 a 1115 mm
- * Terminación en cromado.

GREENWAY. 

Valor sin iva.

Perchero rebatible de 600 a 830 mm / **PR01** \$ 62.360

Perchero rebatible de 830 a 1115 mm / **PR02** \$ 62.360



VOLVER AL INDICE

CORBATERO EXTRAIBLE

- * Profundidad 450 mm
- * 18 ganchos móviles cromados.
- * Telescópicas de extracción total.

Valor sin iva.



Corbatero cromado / 3021 \$ 18.348

TABLA DE PLANCHAR CIERRA SUAVE TUTTI



- * Plegable, extraíble y giratoria.
- * Ancho 300 mm
- * Altura total 140 mm
- * Profundidad 430 mm
- * Largo extendido 800 mm
- * Fácil instalación.



Valor sin iva.

Tabla de planchar Tutti / 10B01 \$ 147.921

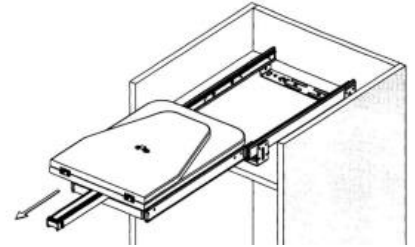

FICHA TÉCNICA



TABLA DE PLANCHAR CIERRA SUAVE BRONZEN



- * Plegable, extraíble y giratoria.
- * Para módulo de 400 mm
- * Altura total 140 mm
- * Fácil instalación.

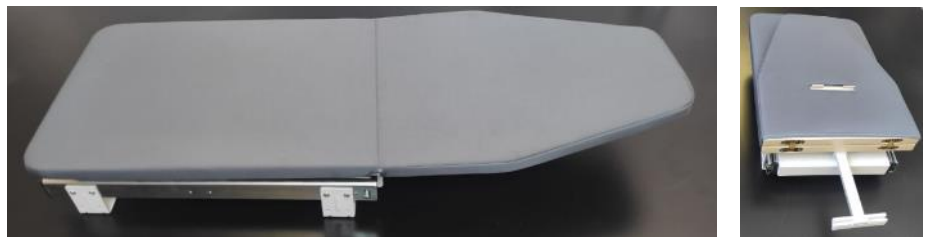

Valor sin iva.

Tabla de planchar Bronzen / LM-400 \$ 140.938

VOLVER AL INDICE

CAÑO OVAL PARA PLACARD

Valor sin iva.

X unidad X 10 unid.

Caño oval cromado x 3 mts / **3315** \$ 5.638 \$ 5.241



Valor sin iva.

X unidad X 10 unid.

Caño oval aluminio anodizado x 3 mts / **OVO** \$ 7.703 \$ 7.160



GRUPO euro
Aluminio hecho producto

* Con ranura para agregar Led base 5 mm

* Ver led en "Iluminación para muebles"

Valor sin iva.

X unidad X 10 unid.

Caño oval aluminio para Led x 3 mts / **TO18.30M** \$ 22.020 \$ 20.470



emr
de Argentina

Valor sin iva.

X unidad X 10 unid.

Caño oval aluminio negro x 3 mts / **L1340NG** \$ 8.101 \$ 7.530



DiMOL

Valor sin iva.

X unidad X 100 unid.

Soporte lateral niquelado / **3015** \$ 325 \$ 302

Soporte lateral negro / **50204NG** \$ 527 \$ 490

Soporte central niquelado / **3115** \$ 595 \$ 553



VOLVER AL INDICE

PERCHEROS

Valor sin iva.

Perchero doble BRIO brillo	/ 27315	\$ 1.700
Perchero doble BRIO mate	/ 26855	\$ 1.700
Perchero triple Dress brillo	/ 27316	\$ 2.256
Perchero triple Dress mate	/ 26856	\$ 2.256



Valor sin iva.

Perchero simple bronce viejo	/ 3300BV	\$ 652
Perchero simple cobre viejo	/ 3300CV	\$ 652
Perchero simple plata vieja	/ 3300PV	\$ 652
Perchero doble negro	/ 3100NG	\$ 1.737
Perchero doble blanco	/ 3100BL	\$ 1.737
Perchero doble cobre viejo	/ 3100CV	\$ 1.737
Perchero doble bronce viejo	/ 3100BV	\$ 1.737
Perchero doble plata vieja	/ 3100PV	\$ 1.737
Perchero triple negro	/ 3200NG	\$ 3.125
Perchero triple blanco	/ 3200BL	\$ 3.125
Perchero triple bronce viejo	/ 3200BV	\$ 3.125
Perchero triple cobre viejo	/ 3200CV	\$ 3.125



TIRADORES
Y MANIJAS.



12

MANIJAS



 [Clic aquí](#)

TIRADORES



 [Clic aquí](#)

CUBETAS



 [Clic aquí](#)

[VOLVER AL INDICE](#)

CORREDERAS PARA CAJON



13

CORREDERA "Z"



 [Clic aquí](#)

LATERAL DE CAJON SIMPLE PARED

* Disponible en color blanco.

* Capacidad de carga 25kg

Valor sin iva.

X unidad X 10 unid.

Lateral de cajón de 86 x 500 mm / 555.94.750 \$ 9.854 \$ 9.160

Lateral de cajón de 118 x 500 mm / 555.95.750 \$ 11.627 \$ 10.809

Lateral de cajón de 150 x 500 mm / 555.96.750 \$ 12.987 \$ 12.072

HÄFELE



TELESCOPICA 35MM DE ALTURA



* Disponible en terminación zincada.

* Capacidad de carga 25kg

 [Clic aquí](#)

TELESCOPICA 45MM DE ALTURA



* Disponible en terminación zincada y negra

* Capacidad de carga de 30kg a 45kg

 [Clic aquí](#)

TELESCOPICA CIERRA SUAVE



- * Disponible en terminación zincada y negra.
- * Capacidad de carga 30kg



TELESCOPICA PUSH TO OPEN



- * Disponible en terminación zincada y negra.
- * Capacidad de carga 30kg



CORREDERA TELESCOPICA CIERRA SUAVE + PUSH TO OPEN

- * Altura 45 mm
- * Disponible en terminación zincada y negra
- * Capacidad de carga 30kg
- * Doble función



Valor sin iva.

X unidad X 15 unid.

Corredera telescópica Greenmove de 400 mm zincada / TGM40Z	\$ 14.192	\$ 13.192
Corredera telescópica Greenmove de 450 mm zincada / TGM45Z	\$ 15.501	\$ 14.409
Corredera telescópica Greenmove de 500 mm zincada / TGM50Z	\$ 17.229	\$ 16.016
Corredera telescópica Greenmove de 400 mm negra / TGM40N	\$ 14.192	\$ 13.192
Corredera telescópica Greenmove de 450 mm negra / TGM45N	\$ 15.501	\$ 14.409
Corredera telescópica Greenmove de 500 mm negra / TGM50N	\$ 17.229	\$ 16.016

CORR. OCULTA CIERRA SUAVE



- * Disponible en terminación zincada.
- * Capacidad de carga 30kg



CORR. OCULTA PUSH TO OPEN



- * Disponible en terminación zincada.
- * Capacidad de carga 30kg



CORREDERA OCULTA CIERRA SUAVE + PUSH TO OPEN

- * Disponible en terminación zincada.
- * Capacidad de carga 30kg
- * Doble función.



Valor sin iva.

X unidad X 10 unid.

Corredera oculta cierra suave y push open de 450 mm / COPF45	\$ 21.671	\$ 20.145
Corredera oculta cierra suave y push open de 500 mm / COPF50	\$ 22.672	\$ 21.076

LATERAL DE CAJON DOBLE PARED CON CIERRA SUAVE



 [Clic aquí](#)

CORREDERA POCKET DOOR

GOLDCENT

Valor sin iva.

Corredera pocket door x 500 mm (por par) / **SL.4507**

\$ 19.240

* Para peso de puerta hasta 20 kg



VOLVER AL INDICE

SISTEMA PUERTA OCULTO SLIDO ECLIPSE

HÄFELE

- * Para peso de puerta hasta 16kg
- * Altura máxima de puerta 1500mm
- * Corredera de 600mm de profundidad
- * Profundidad de introducción 486mm máximo

Para montaje enrasado (Infront), grosor de puerta 16-19 mm

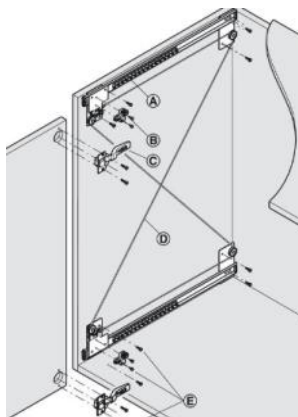

Valor sin iva.

Sistema Slido Eclipse x 600 mm para una puerta / **408.25.360** \$ 95.552

Bisagras para fijación de puerta c/ accesorios por par / **408.24.020** \$ 36.675

BISAGRAS PARA MUEBLES.



14

BISAGRA CIERRA SUAVE



 [Clic aquí](#)

BISAGRA PUSH TO OPEN

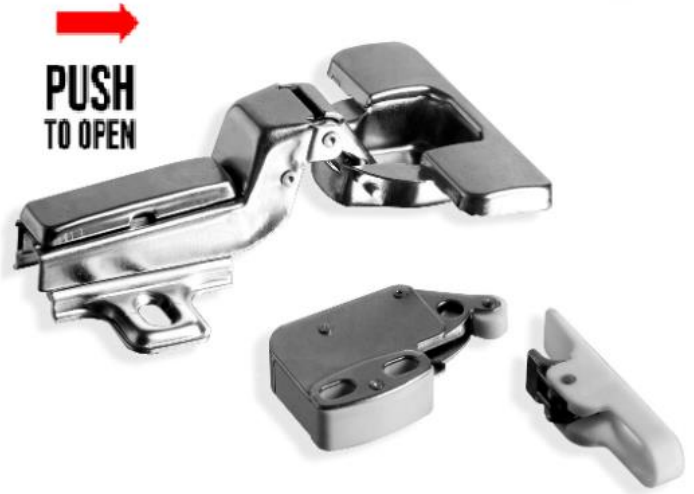

 [Clic aquí](#)

BISAGRA SIMPLE ACCION CAZOLETA 35MM Y 26MM



 [Clic aquí](#)

BISAGRA 180°

Valor sin iva.

X unidad X 100 unid.

Bisagra 35mm codo 180° / **BWC180** \$ 2.013 \$ 1.871

Bisagra 35mm codo 180° cierra suave / **BWC180CF** \$ 4.001 \$ 3.719



VOLVER AL INDICE

BISAGRA INTERMEDIA

Valor sin iva.

X unidad X 100 unid.

Bisagra 35mm intermedia / **BWINT** \$ 1.130 \$ 1.050

GREENWAY. 



BISAGRA PILASTRA "ANGULO CIEGO"

HÄFELE

Valor sin iva.

Bisagra 35 mm ángulo ciego "pilastra" / **311.04.194** \$ 1.136

Placa de montaje Metalla Clip / **311.71.500** \$ 166



GREENWAY. 

Valor sin iva.

Bisagra ángulo ciego con clip Greenway / **GW35AC** \$ 792

BISAGRA PARA ALUMINIO MARCO FINO

GREENWAY. 

Valor sin iva.

Bisagra para aluminio codo 0 / **GWALC0** \$ 1.428

Bisagra para aluminio codo 9 / **GWALC9** \$ 1.428



BISAGRA CON RETEN PARA VIDRIO

Valor sin iva.

Bisagra con retén para vidrio por par / **BRZ-1196** \$ 6.814



BISAGRA OCULTA ACERADA

Valor sin iva.

Bisagra oculta 45 mm x 12 mm acerada x par / **BRZ-5202** \$ 7.688

Bisagra oculta 60 mm x 12 mm acerada x par / **BRZ-5206** \$ 10.763

Bisagra oculta 69 mm x 12 mm acerada x par / **BRZ-5207** \$ 14.277



BISAGRA OCULTA DE PVC

Valor sin iva.

Bisagra oculta de PVC / BRZ-5201 \$ 640



BISAGRA LIBRO

Valor sin iva.

Bisagra libro zinc amarillo de 63 mm / BL63 \$ 230



BISAGRA PIANO

BRONZEN®

Valor sin iva.

Bisagra piano niquel 1800 x 32 mm Bronzen / BRZ-5718 \$ 4.613



HÄFELE

Valor sin iva.

Bisagra piano niquel 3500 x 32 mm Hafele / 351.01.735 \$ 23.463

FRESA PARA PERFORADO DE BISAGRA

Valor sin iva.

Fresa de 26 mm de widia / 50-003 \$ 10.812

Fresa de 35 mm de widia (con tope) / 50-004 \$ 13.675



HERRAMIENTAS GRAMPAS Y CLAVILLOS.

15

GRAMPAS

DORKING
CALIDAD DESDE SIEMPRE

Valor sin iva.

Grampa Dorking 84-08 x 10.000 U	/ DK/1840800H	\$ 9.676
Grampa Dorking 84-10 x 10.000 U	/ DK/1841000H	\$ 11.043
Grampa Dorking 84-12 x 10.000 U	/ DK/1841200H	\$ 12.705
Grampa Dorking 84-14 x 10.000 U	/ DK/1841400H	\$ 15.015
Grampa Dorking 90-15 x 12.670 U	/ DK/1901503	\$ 47.297
Grampa Dorking 90-20 x 9.600 U	/ DK/1902003	\$ 36.873
Grampa Dorking 90-25 x 8.060 U	/ DK/1902503	\$ 36.237
Grampa Dorking 90-30 x 6.800 U	/ DK/1903004	\$ 33.696
Grampa Dorking 90-40 x 4.800 U	/ DK/1904004	\$ 30.728



Cebe

Valor sin iva.

Grampa 90/30 CEBE estuche x 4000 unidades	/ 9030C	\$ 12.989
Grampa 90/40 CEBE estuche x 3000 unidades	/ 9040C	\$ 12.726
Grampa 84/08 CEBE estuche x 16000 unidades	/ 8408C	\$ 11.448
Grampa 84/11 CEBE estuche x 12000 unidades	/ 8411C	\$ 10.668
Grampa 84/14 CEBE estuche x 10000 unidades	/ 8414C	\$ 11.277
Grampa 97/14 CEBE estuche x 6250 unidades	/ 9714C	\$ 6.216



DORKING
CALIDAD DESDE SIEMPRE

CLAVILLOS

Valor sin iva.

Clavillo Dorking tipin 20 x 5000U	/ DK/1032000H	\$ 10.842
Clavillo Dorking tipin 25 x 5000U	/ DK/1032500H	\$ 11.675
Clavillo Dorking tipin 30 x 5000U	/ DK/1033000H	\$ 13.277
Clavillo Dorking tipin 35 x 5000U	/ DK/1033500H	\$ 14.333
Clavillo Dorking tipin 38 x 5000U	/ DK/1033800H	\$ 15.391
Clavillo Dorking tipin 50 x 5000U	/ DK/1035000H	\$ 18.642



VOLVER AL INDICE



Valor sin iva.

Clavillo SK 320 BEA estuche x 5000 unid.	/ SK320CBE	\$ 6.794
Clavillo SK 325 BEA estuche x 5000 unid.	/ SK325CBE	\$ 7.153
Clavillo SK 330 BEA estuche x 5000 unid.	/ SK330CBE	\$ 7.153
Clavillo SK 335 BEA estuche x 5000 unid.	/ SK335CBE	\$ 8.438
Clavillo SK 340 BEA estuche x 5000 unid.	/ SK340CBE	\$ 9.172
Clavillo SK 350 BEA estuche x 5000 unid.	/ SK350CBE	\$ 12.291



METROS Y CINTAS METRICAS

Valor sin iva.

Metro de madera Stabila x 1 mts.	/ 116301	\$ 7.810
Metro de madera Stabila x 2 mts.	/ 116302	\$ 12.496



Valor sin iva.

Metro de madera Hafele x 2 mts.	/ 002.80.203	\$ 9.736
---------------------------------	--------------	----------



Valor sin iva.

Cinta métrica Evel x 2 mts	/ 16102/1	\$ 4.315
Cinta métrica Evel Retroblock x 2 mts	/ 16502/1	\$ 5.124



Valor sin iva.

Cinta métrica Evel Retroblock x 3 mts	/ 16503/1	\$ 6.966
Cinta métrica Evel Retroblock x 5 mts	/ 16505/1	\$ 9.389



Valor sin iva.

Cinta métrica Evel Retroblock reforzada x 5 mts	/ 16525/1	\$ 12.592
---	-----------	-----------



[VOLVER AL INDICE](#)

HÄFELE

Valor sin iva.

Pinza multifunción Hafele / **490.04.000** \$ 21.996



meta

Valor sin iva.

Cutter Mota hoja 18 mm c/ rueda / **C118** \$ 2.806

Repuesto hoja para cutter 18 mm x 10 unid. / **C18** \$ 2.635



Valor sin iva.

Prensas frente de cajón x par / **PFC** \$ 14.200



ESPUMAS ABRASIVAS

Valor sin iva.

Espuma abrasiva médium #280 (Rojo) / **EA280** \$ 2.440

Espuma abrasiva fina #500 (Amarillo) / **EA500** \$ 2.440

Espuma abrasiva extra fina #800 (Verde) / **EA800** \$ 2.440

Espuma abrasiva super fina #1000 (Azul) / **EA1000** \$ 2.440

Espuma abrasiva micro fina #1500 (Lila) / **EA1500** \$ 2.440



LIJA ANTIEMPASTANTE

Valor sin iva.

Lija antiempastante gramaje de 80 / **LAD80** \$ 990

Lija antiempastante gramaje de 100 / **LAD100** \$ 990

Lija antiempastante gramaje de 120 / **LAD120** \$ 990

Lija antiempastante gramaje de 150 / **LAD150** \$ 990

Lija antiempastante gramaje de 180 / **LAD180** \$ 990

Lija antiempastante gramaje de 220 / **LAD220** \$ 990

Lija antiempastante gramaje de 240 / **LAD240** \$ 990

Lija antiempastante gramaje de 280 / **LAD280** \$ 990

Lija antiempastante gramaje de 320 / **LAD320** \$ 990





Valor sin iva.

Lapiz Mota carpintero 180 mm / LP18 \$ 400



Valor sin iva.

Destornillador Mota phillips 100 mm / DPH210 \$ 2.371

Destornillador Mota phillips 150 mm / DPH215 \$ 2.541

Destornillador Mota phillips 25 mm / DPH202 \$ 1.948



BROCAS DE WIDIA



Valor sin iva.

Broca de widia Mota 6 mm / W06 \$ 1.423

Broca de widia Mota 8 mm / W08 \$ 1.882



Valor sin iva.

Broca de widia Fischer 6 mm / 614606 \$ 2.666

Broca de widia Fischer 8 mm / 614608 \$ 3.711



BROCAS ACERO RAPIDO



Valor sin iva.

Broca de acero rápido Mota 2.75mm / M027 \$ 759

Broca de acero rápido Mota 3mm / M03 \$ 759



Valor sin iva.

Film stretch 10 cm cristal / **FM-10** \$ 1.847



Valor sin iva.

Film stretch 50 cm cristal / **FM-50** \$ 13.967



Valor sin iva.

Cinta embalaje 48 mm x 100 mts transparente / **CTR** \$ 1.717



Valor sin iva.

Cinta impresa frágil 48 mm x 50 mts / **CFR** \$ 2.127



Valor sin iva.

Cinta papel enmascarar 18 mm x 50 mts / **CPE18** \$ 1.362



ADHESIVO PROFESIONAL.

16

COLA VINILICA

Valor sin iva.

Fana cola vinílica 1011 pomo x 125 grs	/ 946	\$ 822
Fana cola vinílica 1011 pomo x 1kg	/ 928	\$ 3.519
Fana cola vinílica 1011 pote x 1kg	/ 952	\$ 3.615
Fana cola vinílica 1011 pote x 4kg	/ 957	\$ 13.019
Fana cola vinílica 1011 balde x 20kg	/ 958	\$ 63.175



Valor sin iva.

Fana cola vinílica 1022 pote x 4kg	/ 869	\$ 18.905
------------------------------------	-------	-----------



* Adhesivo vinílico de gran transparencia recomendado para el pegado de todo tipo de maderas entre sí, como laminados, terciados fenólicos, aglomerados o enchapados, brinda anclajes rápidos y tenaces otorgando excelente elasticidad y cohesión generando uniones resistentes al impacto y la tracción por encima de los valores de rotura del madera.

Valor sin iva.

Adhesivo vinílico K-1000 1 kg	/ K-1000/1	\$ 3.891
Adhesivo vinílico K-1000 4 kg	/ K-1000/4	\$ 15.563
Adhesivo vinílico K-1000 22 kg	/ K-1000/22	\$ 74.476



* Adhesivo vinílico de rápido secado y tiempos cortos de prensado. Recomendado para entarugado de todo tipo de maderas, ensamble de muebles y aberturas, pegado de marcos, cartones, telas, etc. Forma películas transparentes de excelente adherencia y gran fuerza de unión, permitiendo su lijabilidad.

Valor sin iva.

Adhesivo vinílico K-5 500 gr	/ K-5/1/2	\$ 3.669
Adhesivo vinílico K-5 1kg	/ K-5/1	\$ 7.226



* Adhesivo vinílico de elevada elasticidad especialmente formulado para el pegado de parquets, sobre carpeta cementicia, mármol, baldosa, cerámicos, etc. De gran tenacidad y rápido anclaje con menor transferencia de humedad a la madera.

Valor sin iva.

Adhesivo vinílico K-1004 1 kg	/	K-1004/1	\$ 3.891
Adhesivo vinílico K-1004 5 kg	/	K-1004/5	\$ 13.339
Adhesivo vinílico K-1004 25 kg	/	K-1004/25	\$ 58.914



* Adhesivo vinílico ultra resistente y de rápido secado, cumple los requisitos de la clase D3. Excelente para carpintería de interior y exterior, fabricación y reparación de instrumentos musicales. Es equivalente al Titebond II

Valor sin iva.

Adhesivo vinílico K-1050 1 kg	/	K-1050/1	\$ 8.893
-------------------------------	---	-----------------	----------



Valor sin iva.

Zaff cola vinílica pomo x 1kg	/	31000/2	\$ 4.652
Zaff cola vinílica pote x 1kg	/	31000/1	\$ 4.652



Valor sin iva.

Fana cola vinílica D3 Ultimate pomo x 500 gr	/	930	\$ 7.336
Fana cola vinílica D3 Ultimate pomo x 1kg	/	931	\$ 13.819



ADHESIVO POLIURETANO

* Purkol es un adhesivo monocomponente que retícula con la humedad generando una espuma de adherencia superior resistente a altas temperaturas. Recomendable para el encolado de puertas, ventanas, sillas, placas minerales para la construcción, materiales de cerámica, cemento, armado de escaleras, decks, etc.

Valor sin iva.

Adhesivo poliuretánico PUR 500 grs	/	KS-518	\$ 7.782
------------------------------------	---	---------------	----------



VOLVER AL INDICE

Valor sin iva.

Fanatite 520 poliuretano pomo 50 grs / 259	\$ 1.621
Fanatite 520 poliuretano pomo 330 grs / 293	\$ 5.524
Fanatite 520 poliuretano pomo 1KG / 258	\$ 13.915



LINEA ALTA TITEBOND



ORIGINAL WOOD GLUE

- * Uso general: interior.
- * Color seco : Beige
- * Resistencia : 3600 PSI

Valor sin iva.

Titebond Original 8oz / 236 ml / 0639	\$ 9.260
Titebond Original 16oz / 473 ml / 0646	\$ 16.035
Titebond Original 1/4 galón / 946 ml / 0653	\$ 26.752
Titebond Original 1 galón / 3785 ml / 0660	\$ 80.855



PREMIUM II WOOD GLUE

- * Uso general: interior y exterior
- * Color seco : Beige
- * Resistencia: 3750 PSI

Valor sin iva.

Titebond Premium 8oz / 236ml / 0035	\$ 11.121
Titebond Premium 16oz / 473ml / 0042	\$ 19.241
Titebond Premium 1/4galón / 946ml / 0059	\$ 32.013
Titebond Premium 1galón / 3785ml / 0066	\$ 96.870



ULTIMATE III WOOD GLUE

- * Uso general: interior y exterior
- * Color seco : Marrón
- * Resistencia: 4000 PSI

Valor sin iva.

Titebond Ultimate 8oz // 236ml	/ 4136	\$ 15.780
Titebond Ultimate 16oz / 473ml	/ 4143	\$ 27.213
Titebond Ultimate 1/4galón / 946ml	/ 4150	\$ 45.066
Titebond Ultimate 1galón / 3785ml	/ 4167	\$ 136.401



QUICK & THICK Multi-surface

- * Uso general: interior
- * Color seco : Transparente

Valor sin iva.

Titebond Quick & Thick 8oz/ 236ml	/ 4036	\$ 11.657
-----------------------------------	--------	-----------



TITEBOND SPEED SET

* El pegamento para madera Titebond Speed Set tiene un fraguado extremadamente rápido. Proporciona propiedades excepcionales de relleno de huecos que desarrollan una unión más fuerte que la propia madera. Este producto ofrece una excelente capacidad de lijado, no se ve afectado por los acabados y aumenta la productividad a través de su tiempo de sujeción más corto sin aumento de la viscosidad.

Valor sin iva.

Titebond Speed Set 8oz / 236 mm	/ 3631	\$ 10.080
---------------------------------	--------	-----------



* El adhesivo de construcción de uso múltiple.

Titebond All Purpose es una fórmula versátil diseñada para aplicaciones interiores y exteriores de uso general que une materiales de construcción comunes. Es altamente resistente al agua y ofrece un tiempo de trabajo más prolongado para un montaje preciso sin dejar de ser permanentemente flexible.

Adhiere madera, metal, ladrillo, mármol etc.



Valor sin iva.

Titebond All Purpose 10oz / 310 mm / **4516** \$ 12.183



* Titebond Subfloor es un adhesivo extra fuerte ideal para paneles como OSB, Mdf y contrachapados. Resistente a la humedad, reduce notoriamente la utilización de clavos o tornillos.

Valor sin iva.

Titebond Subfloor 10oz / 310 mm / **4811** \$ 11.040



ADHESIVOS DE CONTACTO

Valor sin iva.

Fanacola Adhesivo de contacto 96 con tolueno 750gs / **138** \$ 9.725

Fanacola Adhesivo de contacto 96 con tolueno 2.8kg / **139** \$ 32.094



Valor sin iva.

Fanacola Adhesivo de contacto x-90 sin tolueno 40gs / **131** \$ 1.451

Fanacola Adhesivo de contacto x-90 sin tolueno 750gs / **145** \$ 9.309

Fanacola Adhesivo de contacto x-90 sin tolueno 2.8Kg / **136** \$ 30.569



Valor sin iva.

Zaff Adhesivo de contacto C15 con tolueno 1kg / **21000/1** \$ 10.967

Zaff Adhesivo de contacto C15 con tolueno 4kg / **24000/1** \$ 40.308



* Adhesivo para piso alfombra. Decoración

Valor sin iva.

Adhesivo de contacto K-2018 2.8 Kg / **K-2018/2.8** \$ 22.232

* Adhesivo de elevada elasticidad y elevado tiempo abierto, ideal para unir todo tipo de materiales entre sí como laminados plásticos, alfombras, telas, corchos, metales, cueros y gomas o a superficies de madera, metal o yeso

Valor sin iva.

Adhesivo de contacto K-2024 750g / **K-2024/750** \$ 7.782

Adhesivo de contacto K-2024 2.8kg / **K-2024/2.8** \$ 24.455



LACAS

Valor sin iva.

Laca brillante x 1L / **K-4035B/1** \$ 14.451

Laca semi - mate x 1 L / **K-4035SM/1** \$ 14.451

Laca extra - mate x 1 L / **K-4039EM/1** \$ 25.567



SILICONAS

Valor sin iva.

Silicona neutra N700 Zaffix 280 cc / **N700** \$ 5.035

Silicona acética A300 Zaffix 280 cc / **A300** \$ 4.300

Sellador acrílico blanco AC700 Zaffacryl 280 cc / **AC700** \$ 2.786





		Valor sin iva.
Silicona neutra transparente x 260 ml	/ 600689	\$ 5.733
Sellador acrílico Premium pintable x 310 ml	/ 545072	\$ 5.033
Fischer pegado total x 310 ml	/ 566965	\$ 7.164



		Valor sin iva.
Pistola para cartucho Fischer	/ 053115	\$ 27.821



		Valor sin iva.
Pistola para cartucho Reforzada Zaff	/ 90365	\$ 9.557



ESPUMAS POLIURETANICAS



* Espuma poliuretánica de 1 componente endurecible con la humedad.

Adhiere sobre hormigón, mampostería, madera y plásticos.

Contenido: 500 ml.

Rendimiento máximo: 30 litros.

Origen: Alemania.

		Valor sin iva.
Espuma poliuretánica Fischer x 500 ml	/ 094727	\$ 10.910



		Valor sin iva.
Espuma poliuretánica ZAFF x 500 ml	/ 90500/1	\$ 6.396



HERRAJES DE OBRA.



17



Valor sin iva.

Picaporte doble balancín 01 recto acero inox. / **GWMP01** \$ 8.256



Valor sin iva.

Picaporte doble balancín 02 curvo acero inox. / **GWMP02** \$ 9.617



Valor sin iva.

Picaporte doble balancín 03 plano acero inox. / **GWMP03** \$ 13.521



Valor sin iva.

Picaporte doble balancín 04 barra acero inox. / **GWMP04** \$ 12.959



Valor sin iva.

Picaporte recto 05 + manijón acero inox. / **GWMP05** \$ 11.839



Valor sin iva.

Llavín para baño acero inoxidable / **BRZ-1026** \$ 6.054

Llavín para baño acero inox.(libre-ocupado) / **BRZ-1025** \$ 6.054



* Cierra puerta con freno a 90°

Valor sin iva.

Cierra puerta aéreo 45 a 60 KG / **29417** \$ 18.659



VOLVER AL INDICE